

AQU@FAN : FITTING THE REAR INTAKE DAMPER (RVCA-RT MOTORISED OR RVCM-RT MANUAL)

AQU@FAN : MONTAGE DU VOLET DE REPRISE ARRIERE (MOTORISE RVCA-RT OU MANUEL RVCM-RT)

AQU@FAN : MONTAGE DER ANSAUGKLAPPE HINTEN (MIT MOTORANTRIEB RVCA-RT ODER MANUELL RVCM-RT)

AQU@FAN : MONTAGGIO DELLO REGISTRO ASPIRAZIONE ARIA POSTERIORE (MOTORIZZATO RVCA-RT O MANUELE RVCM-RT)

AQU@FAN : MONTAJE DEL REGISTRO DE RETORNO TRASERA (MOTORIZADA RVCA-RT O MANUAL RVCM-RT)



x 1



RVCA-RT



RVCM-RT



x 1



x 8

1

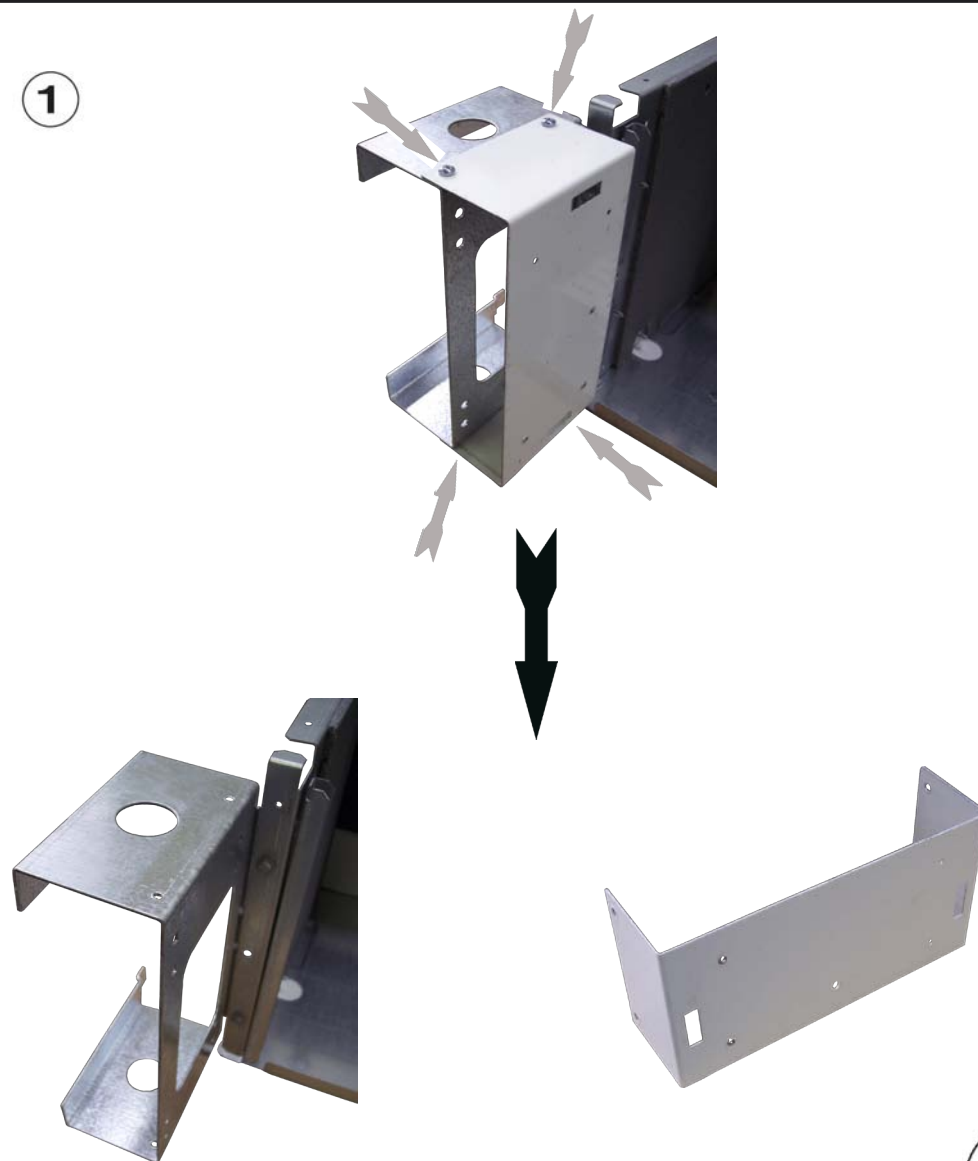

2



X2

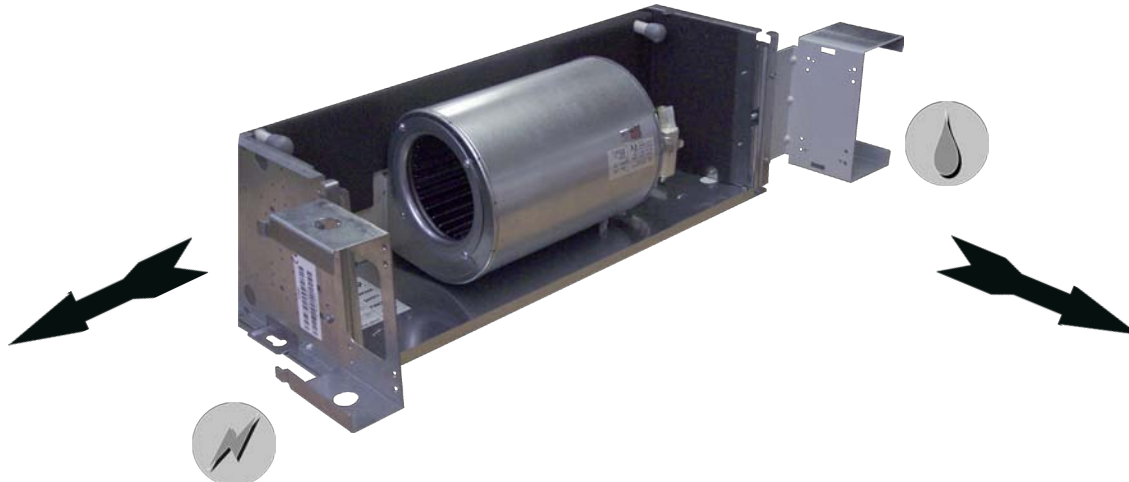

X4

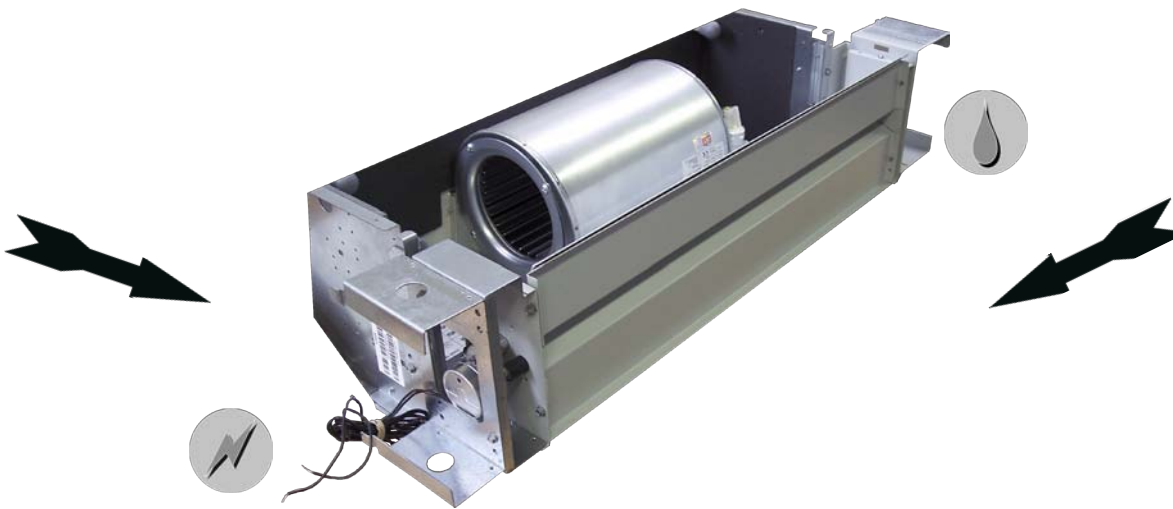

3

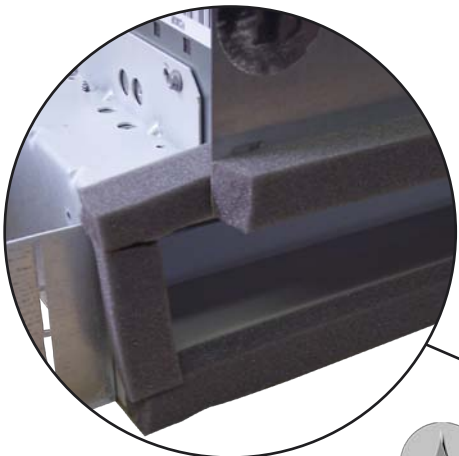
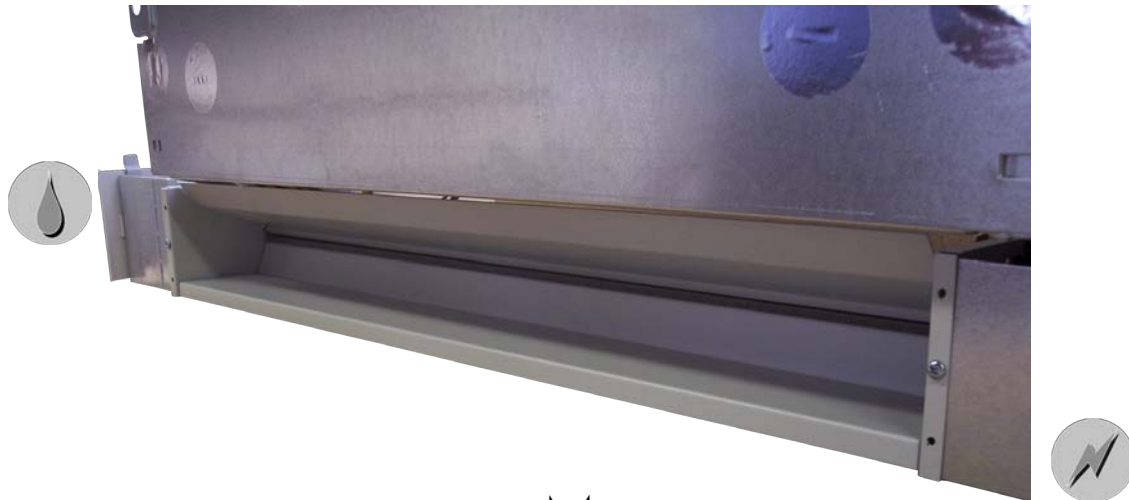

4

ADJUST THE POSITION OF THE MANUAL RVCM-RT DAMPER
REGLER LA POSITION DU VOLET MANUEL RVCM-RT
DIE POSITION DER MANUELLEN KLAPPE RVCM-RT EINSTELLEN
REGOLARE LA POSIZIONE DELLO REGISTRO MANUALE RVCM-RT
AJUSTAR LA POSICIÓN DEL REGISTRO MANUAL RVCM-RT

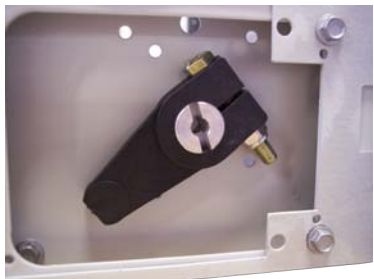
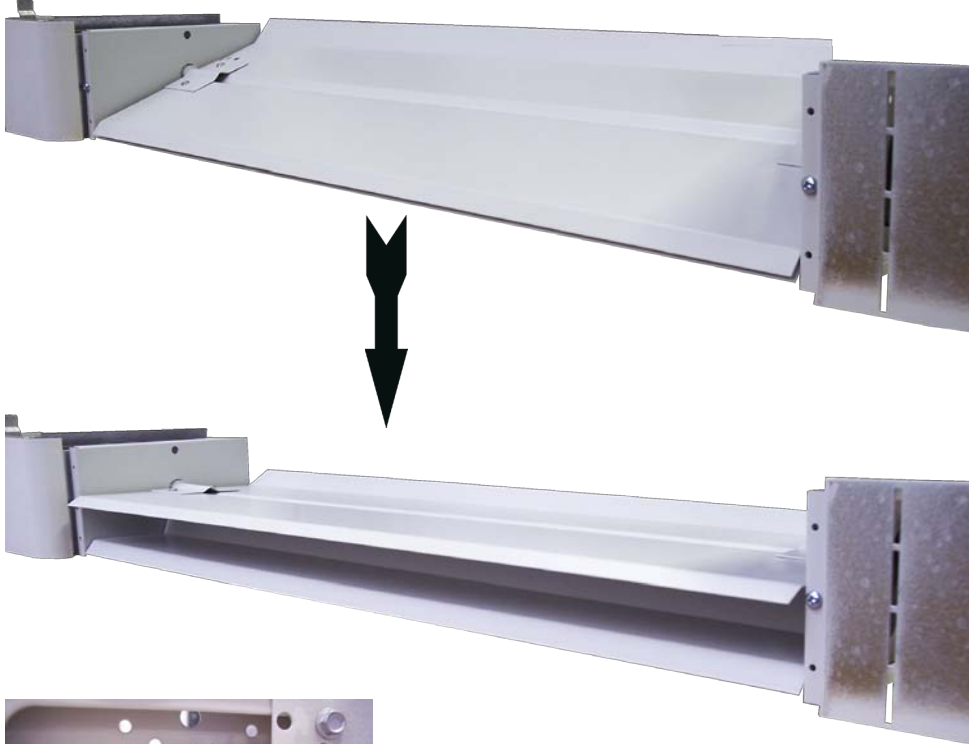

BLOCK THE ADJUSTMENT
BLOQUER LE REGLAGE
DIE EINSTELLUNG SPERREN
BLOCCARE LA MESSA A PUNTO
BLOQUEAR EL AJUSTE

5

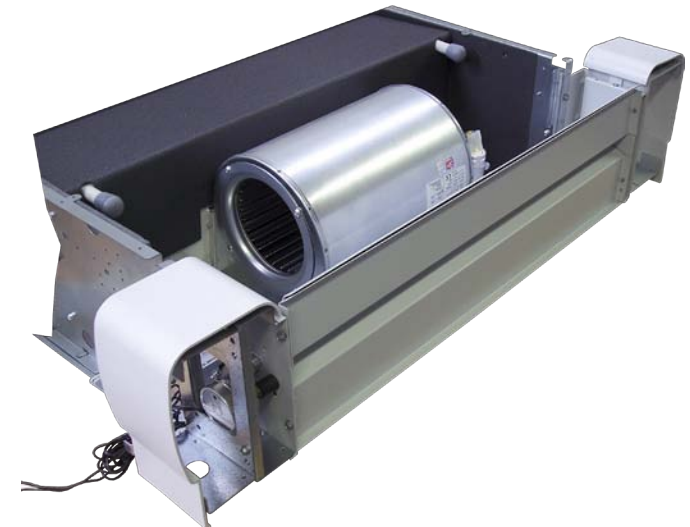
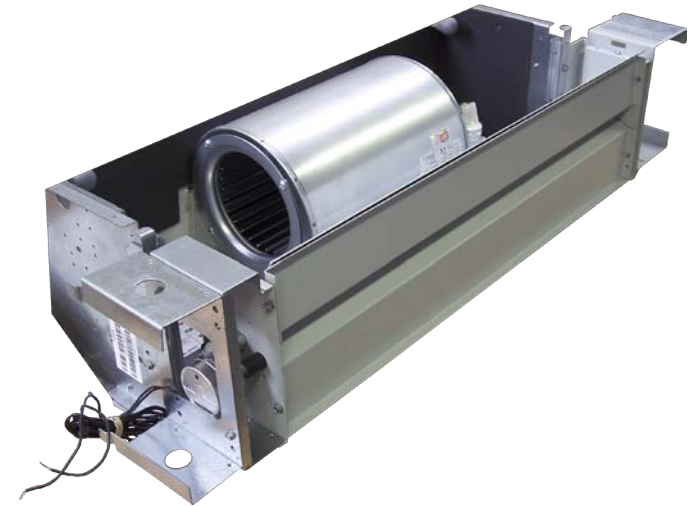

DIMENSIONS AND POSITION FOR DRILLING HOLES IN THE WALL

DIMENSION ET POSITION DU PERCAGE DANS LE MUR

MAßE UND POSITION DER BOHRUNGEN DER RÜCKWAND

DIMENSIONE E POSIZIONE DELLA FORATURA NEL MURO

DIMENSIÓN Y POSICIÓN DEL TALADRADO EN EL MURO

	A	X	X1	Y	Y1
20	480	500	768	210	250
30	665	685	953	210	250
40	850	870	1138	210	250
50	1035	1055	1323	210	250
60	1220	1240	1508	210	250
70	1035	1055	1323	208	257
80	1220	1240	1508	208	257
90	1405	1425	1693	208	257

