

**AQU@FAN: CONDENSATE LIFT PUMP - AWC AWN**  
**AQU@FAN: KIT POMPE RELEVAGE DES CONDENSATS - AWC AWN**  
**AQU@FAN: BAUSATZ KONDENSWASSERFÖRDERPUMPE - AWC AWN**  
**AQU@FAN: KIT POMPA DI SOLLEVAMENTO DELLE CONDENSE - AWC AWN**  
**AQU@FAN: KIT BOMBA DE ELEVACIÓN DE CONDENSADOS - AWC AWN**



**POWER SUPPLY MUST BE SWITCHED OFF BEFORE STARTING TO WORK IN THE ELECTRIC CONTROL BOX!**

**MISE HORS TENSION OBLIGATOIRE AVANT TOUTE INTERVENTION DANS LES BOITIERS ELECTRIQUES.**

**VOR JEDEM EINGRIFF AN DEN ANSCHLUSSKÄSTEN UNBEDINGT DAS GERÄT STROMLOS SCHALTEN!**

**PRIMA DI OGNI INTERVENTO SULLE CASSETTE ELETTRICHE ESCLUDERE TASSATIVAMENTE L'ALIMENTAZIONE !**

**PUESTA FUERA DE TNSIÓN OBLIGATORIA ANTES DE CUALQUIER INTERVENCIÓN EN LAS CAJAS ELÉCTRICAS!**

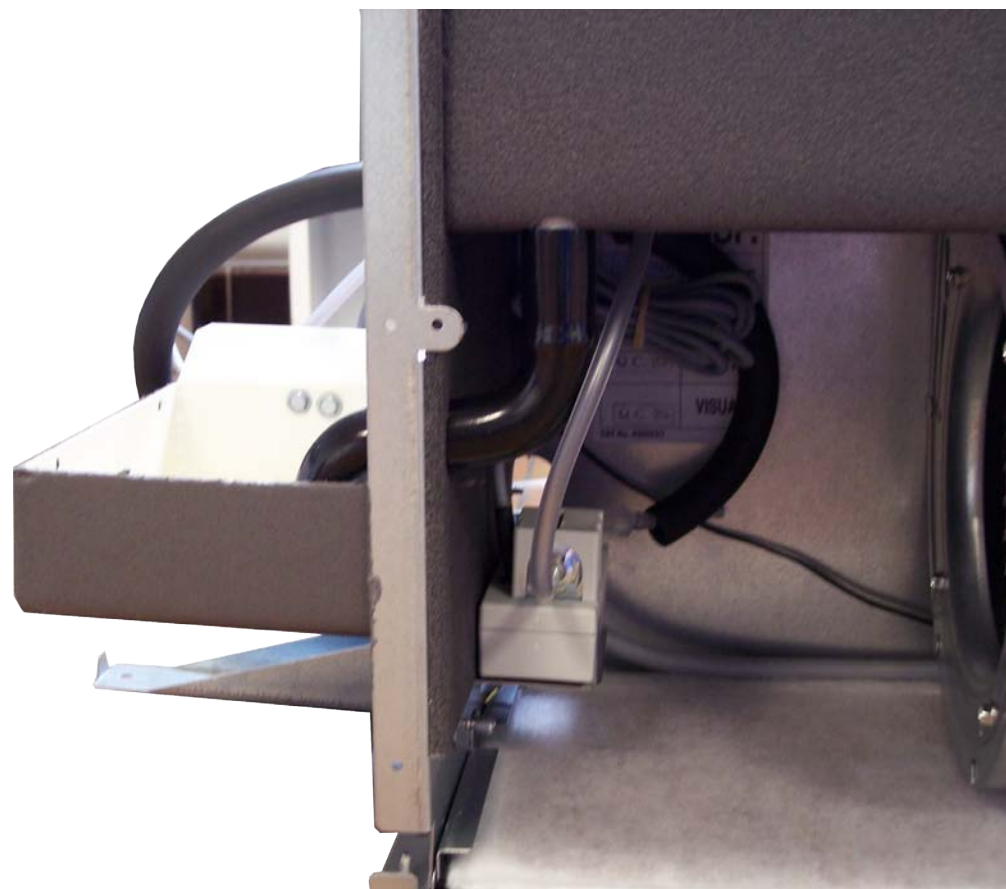

①

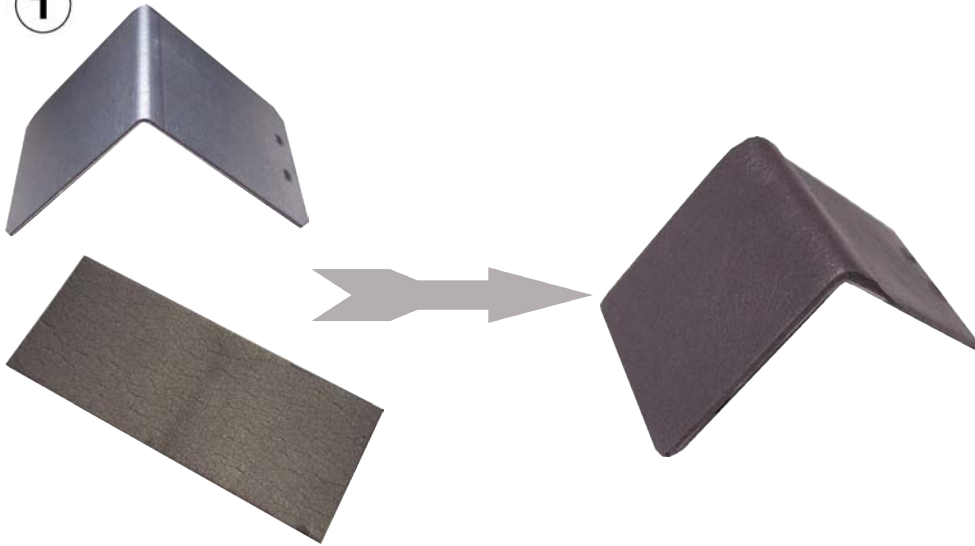

②

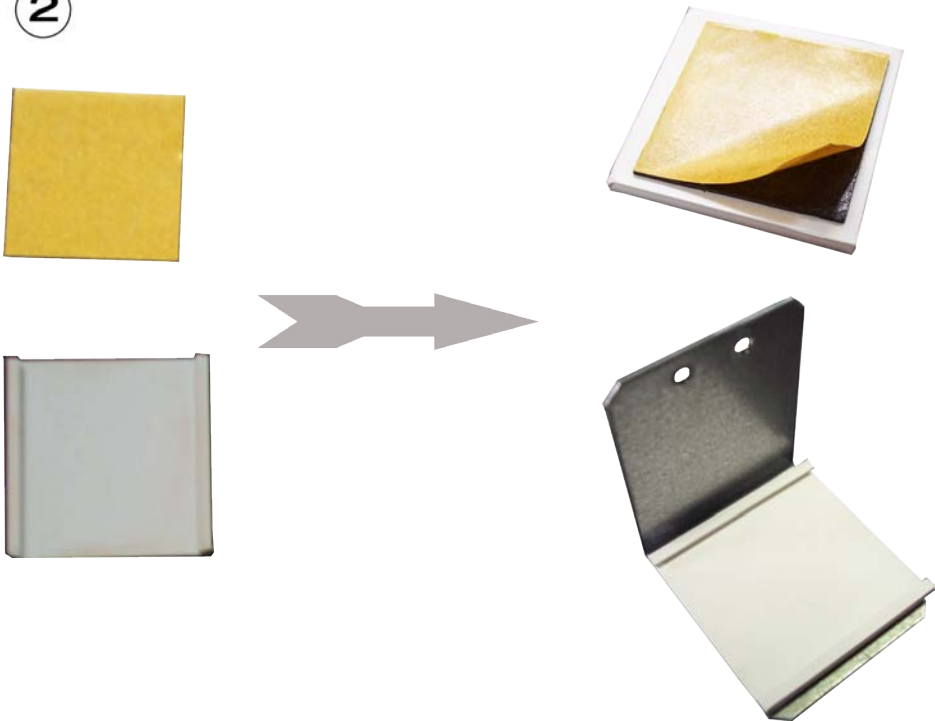

③

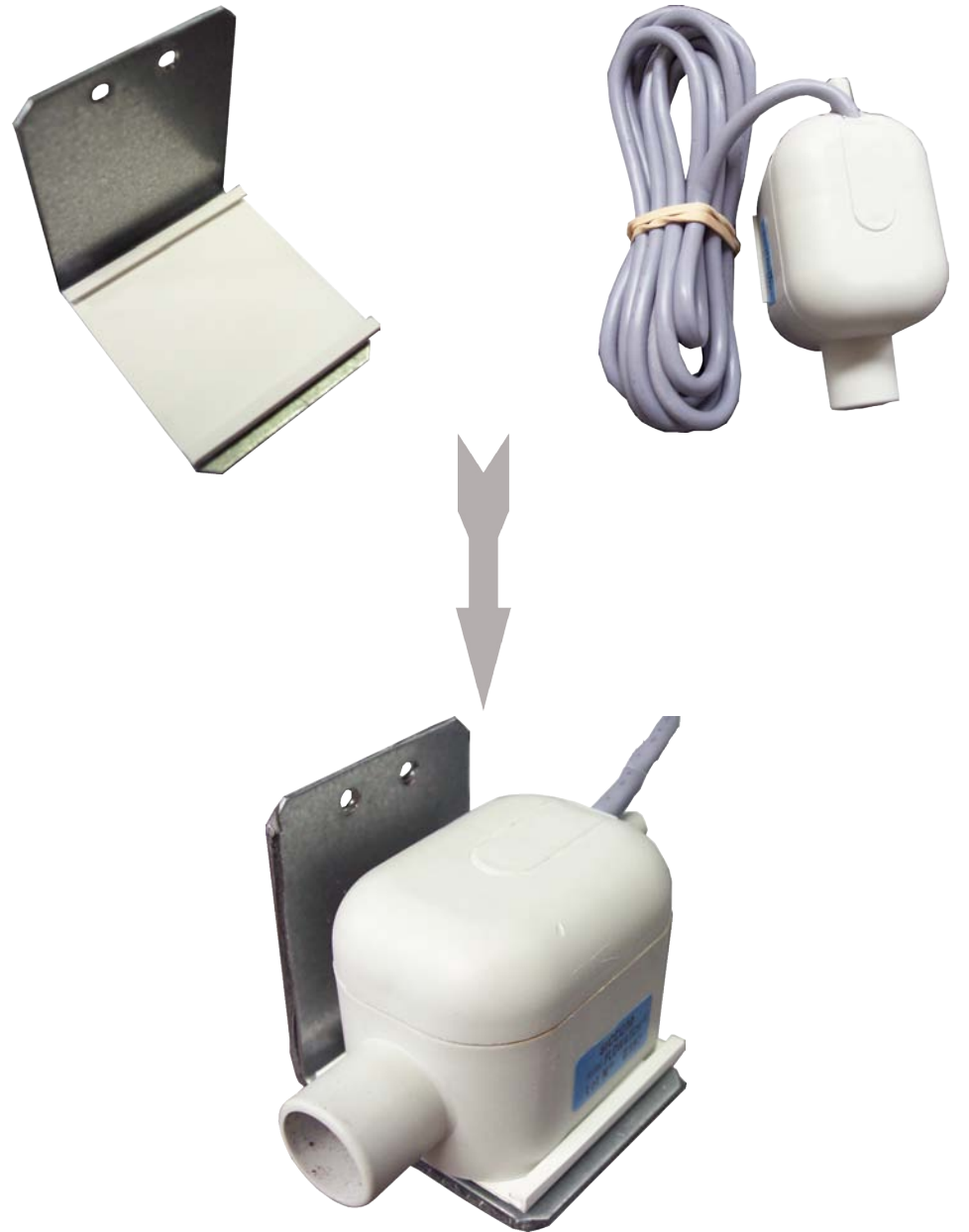

OPERATING FACE  
FACE DE SERVICE  
WARTUNGSSEITE  
FACCIATA DI SERVIZIO  
CARA DE SERVICIO

LEFT  
GAUCHE  
LINKS  
SINISTRA  
IZQUIERDA

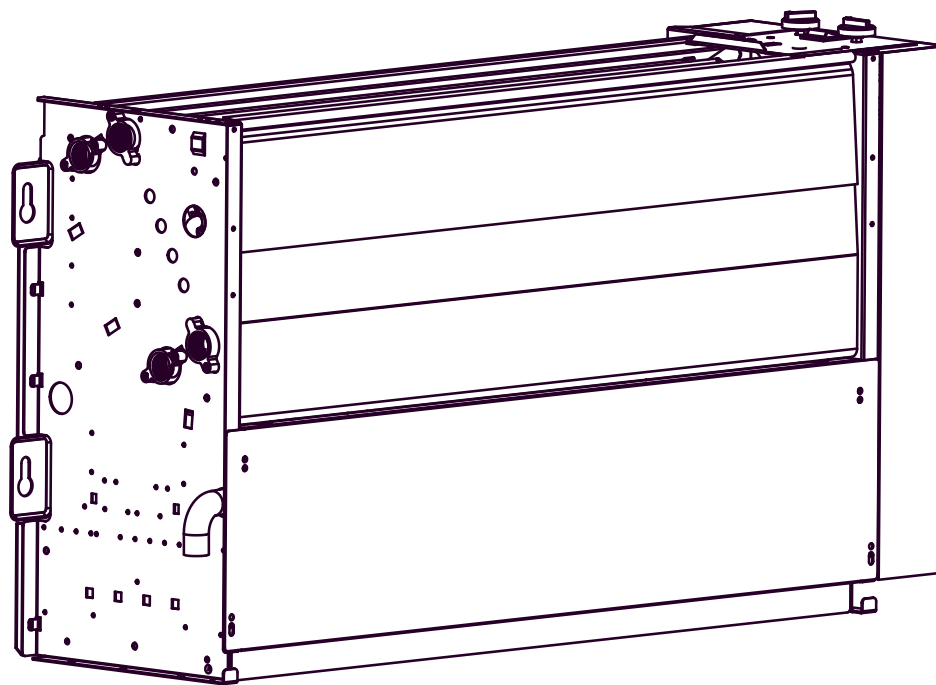

Left  
Gauche  
Links  
Sinistra  
Izquierda

Right  
Droite  
Rechts  
Destra  
Derecha

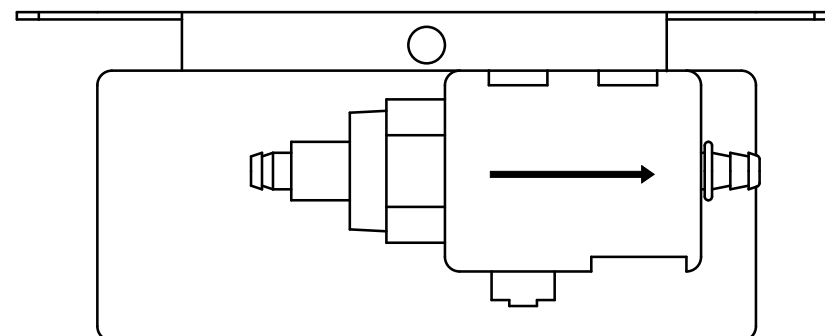
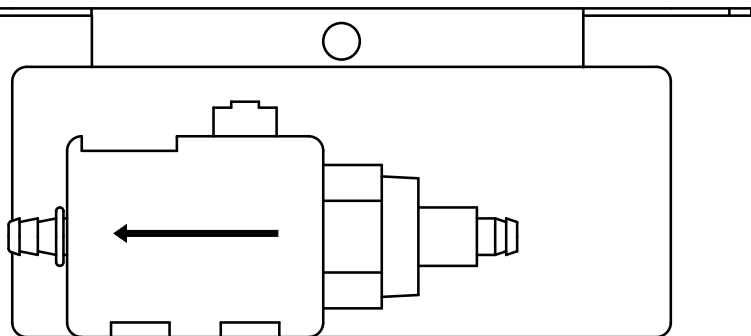

④

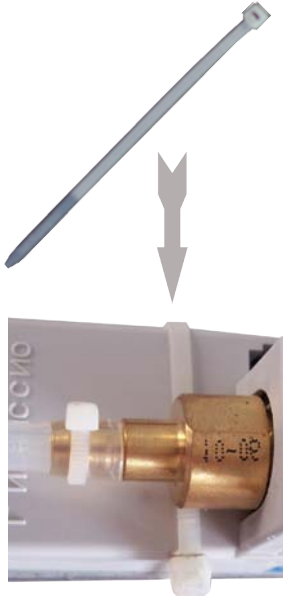
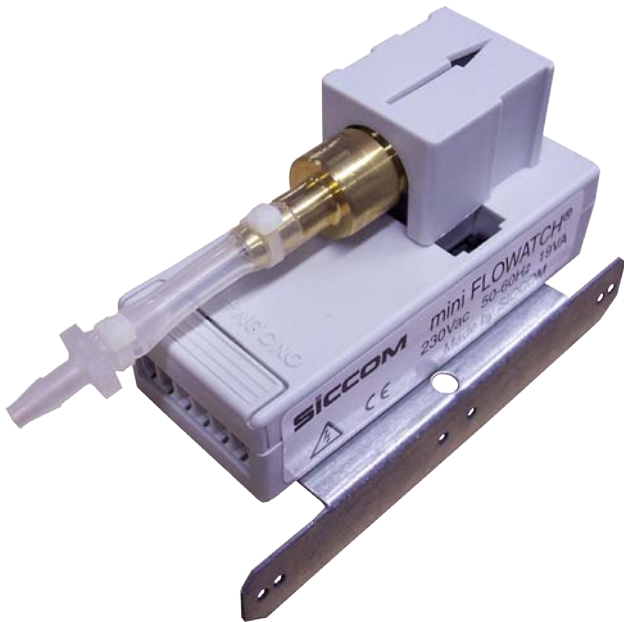
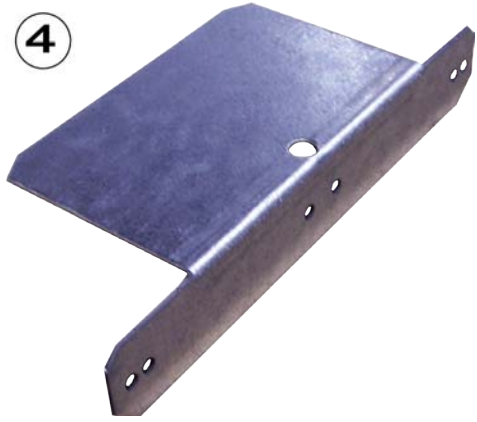

⑤

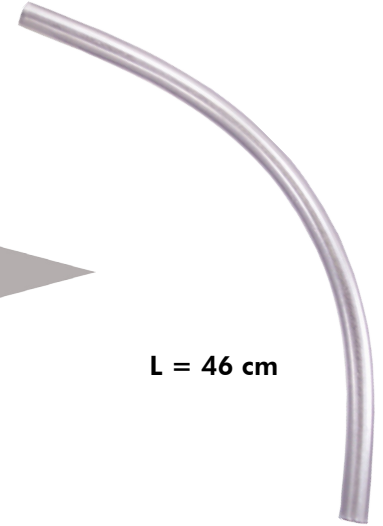

L = 46 cm

⑥



7

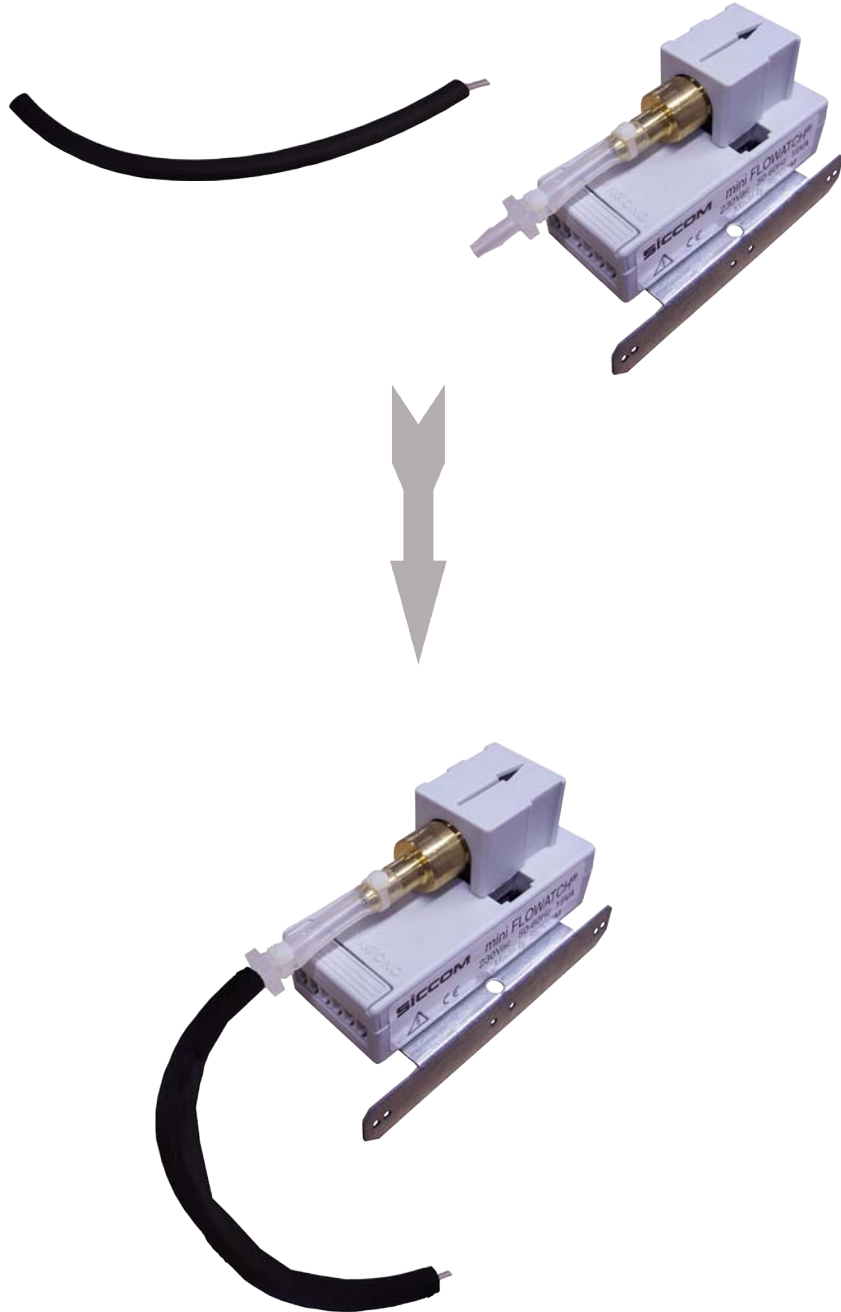

8

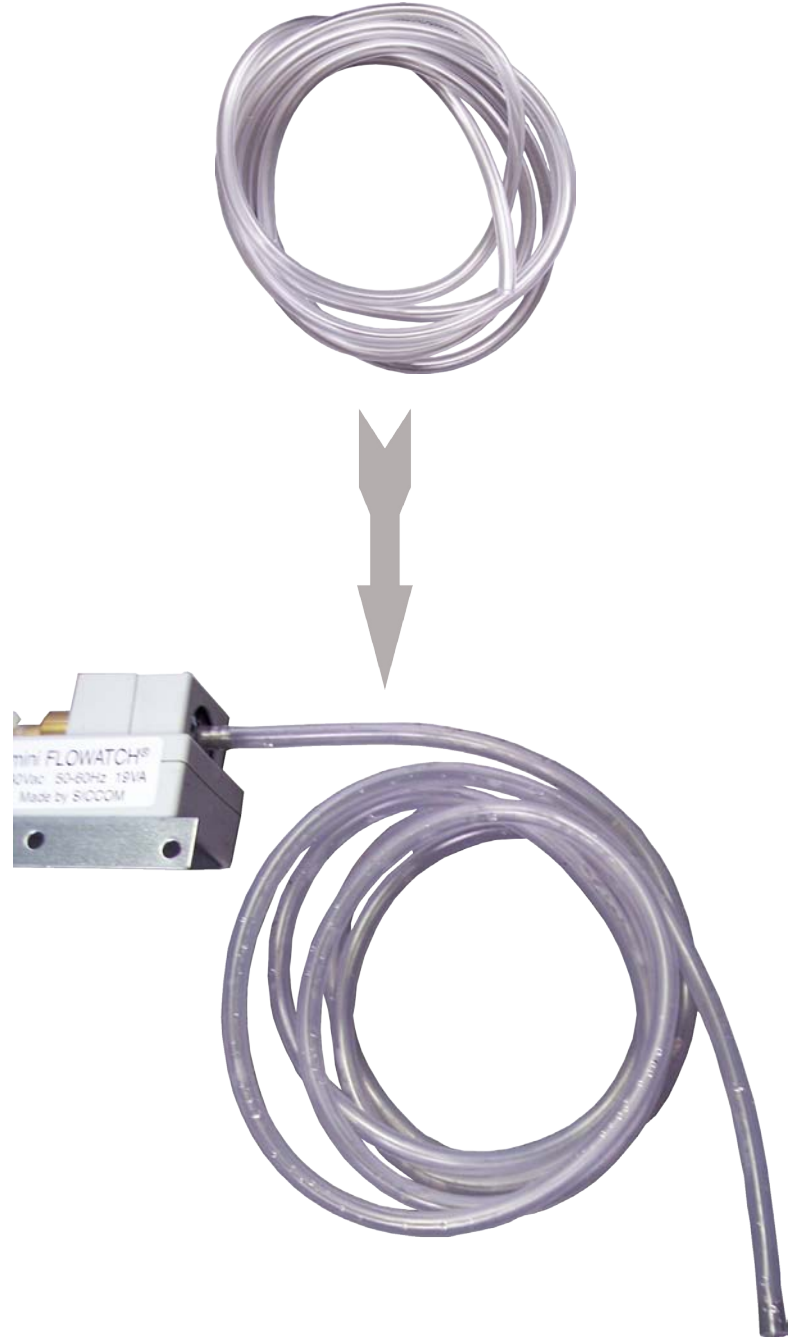

9

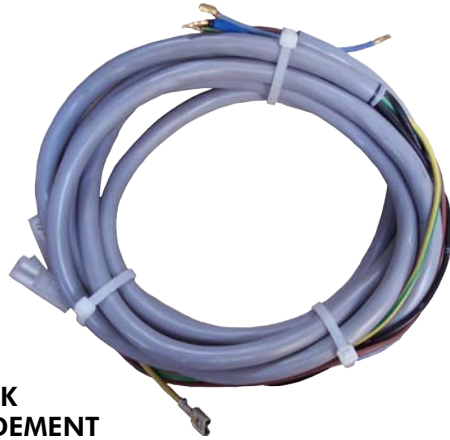

TERMINAL BLOCK  
BORNIER DE RACCORDEMENT  
KLEMMLEISTE  
MORSETTI SCATOLA ELECT.  
BORNERA DE CONEXION

AQUANET

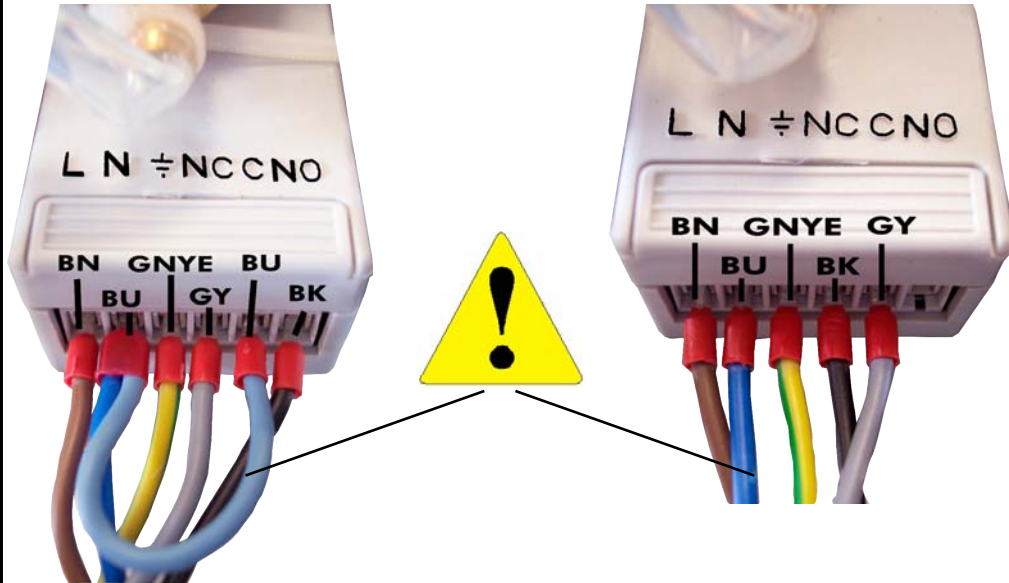

10

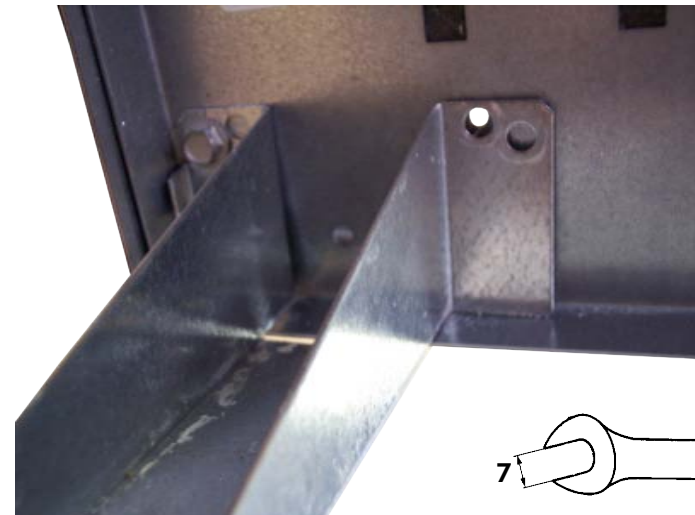

11

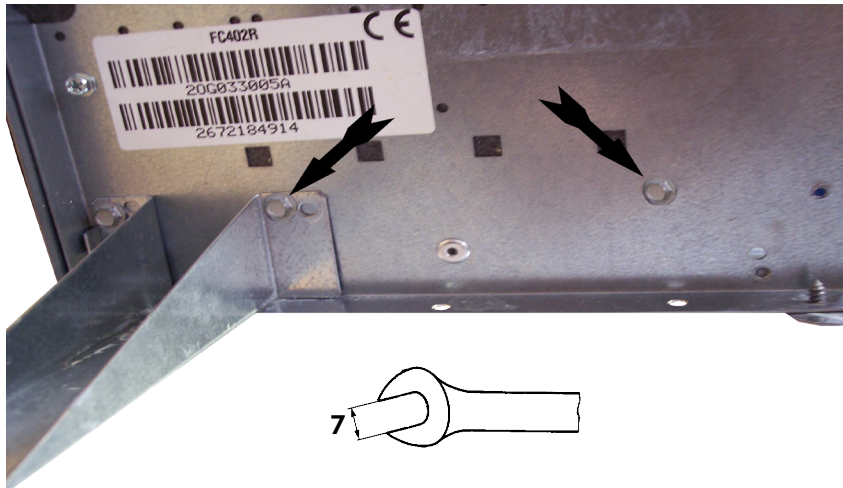
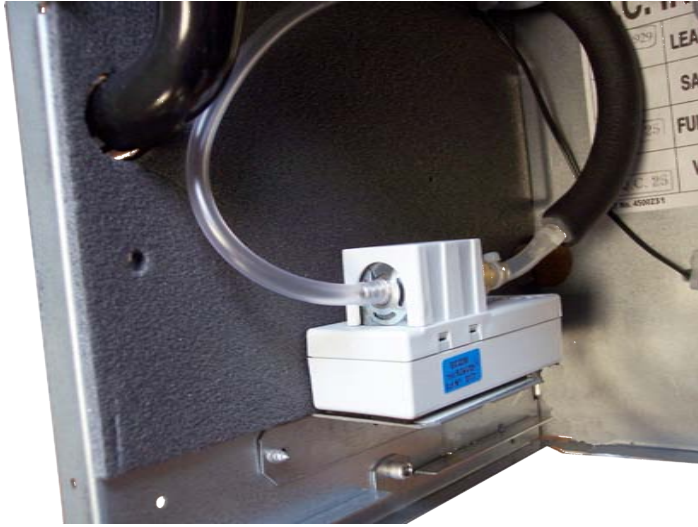

12

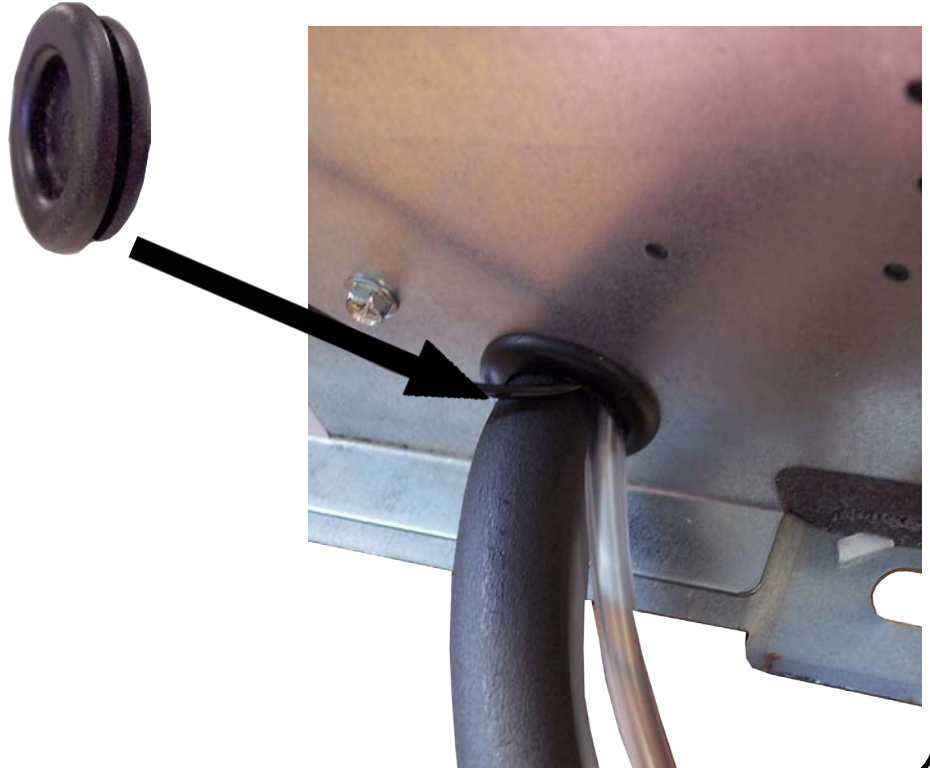

13



14

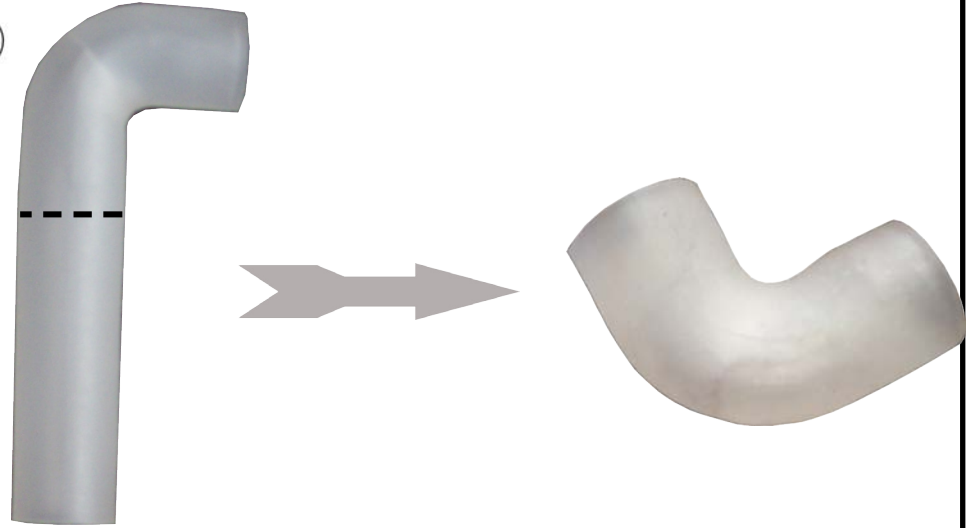

15

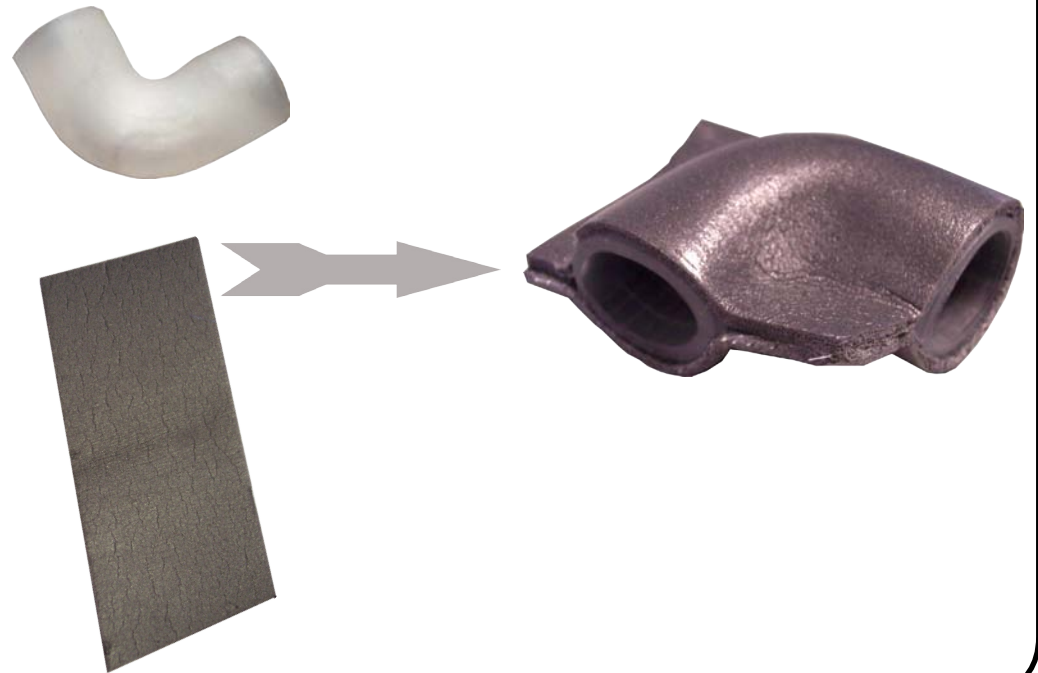



16



17

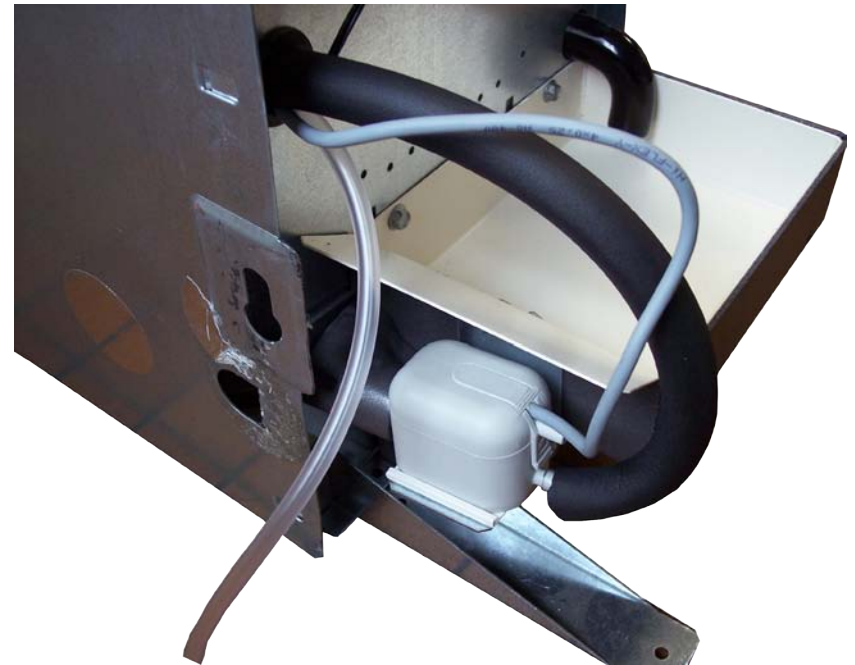
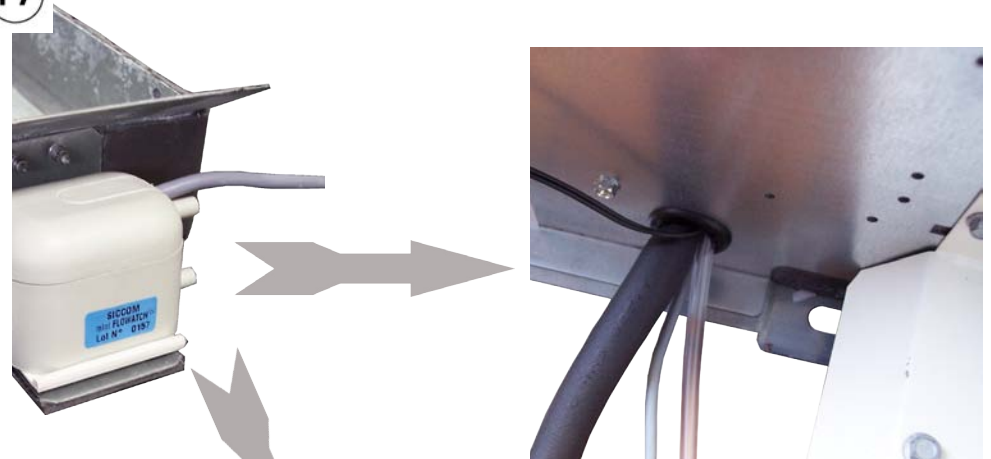

18

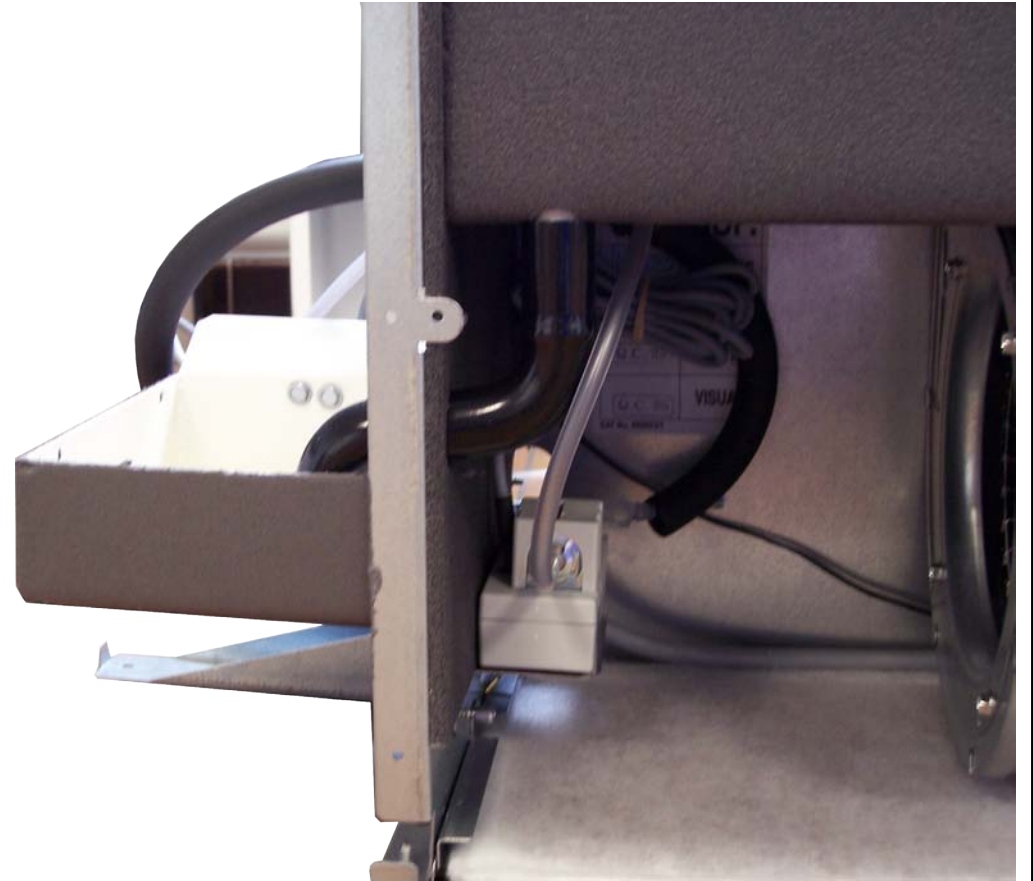
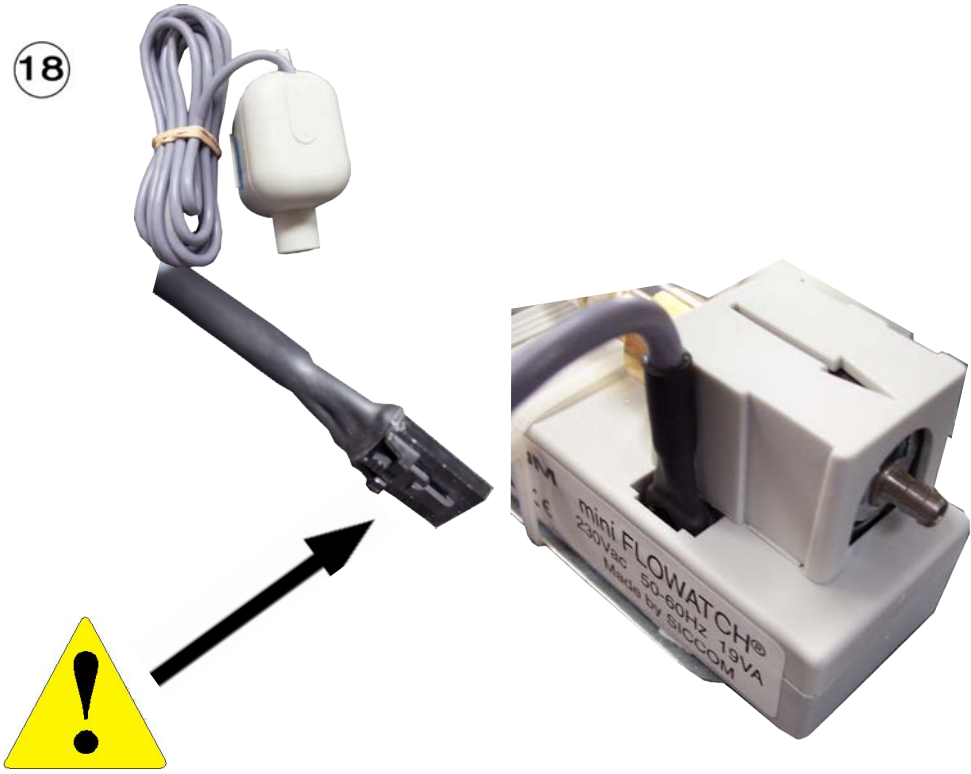

19

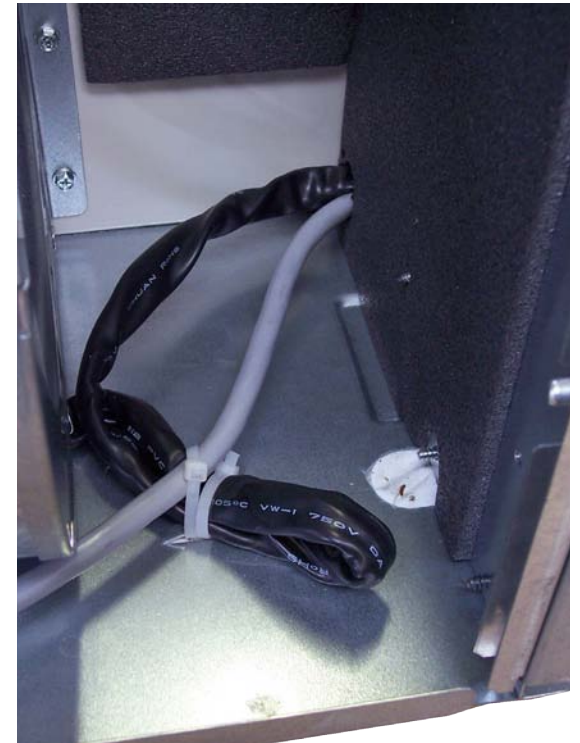

SE 3608  
 CODE 399986  
 230V-50/60Hz

# OPTION POMPE DE RELEVAGE-MONTAGE SUR AQUAFAN

## MODELE BORNIER

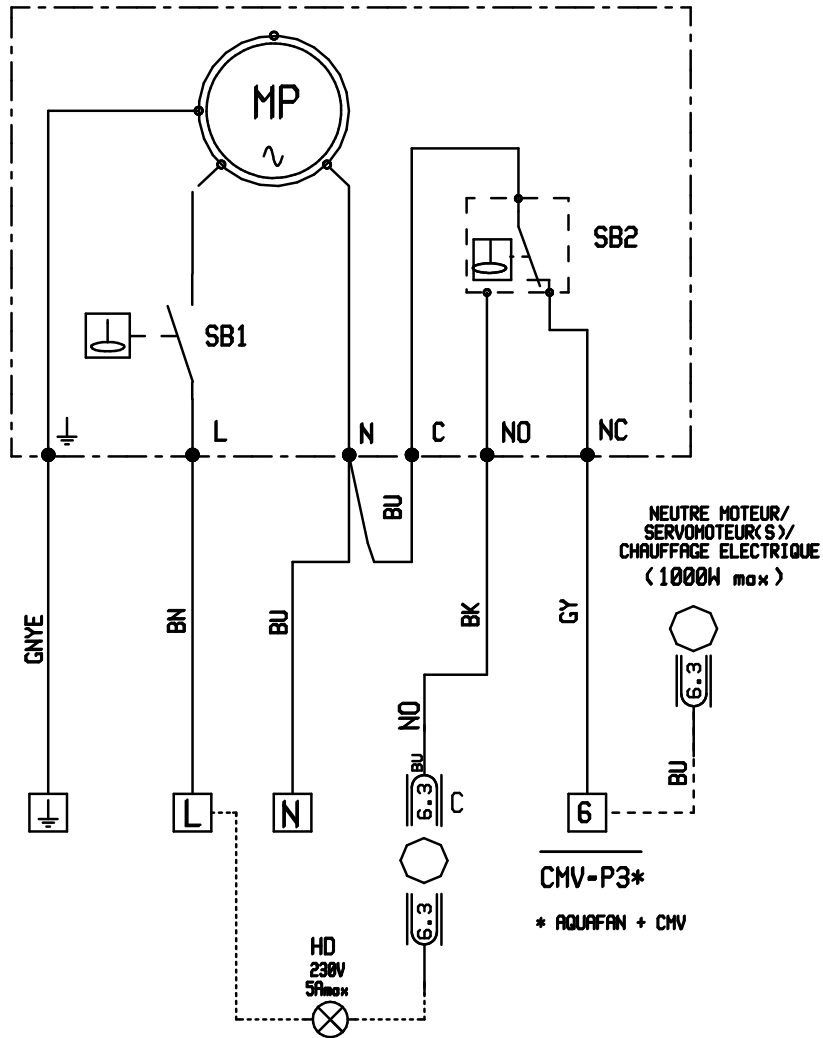

## MODELE AQUANET

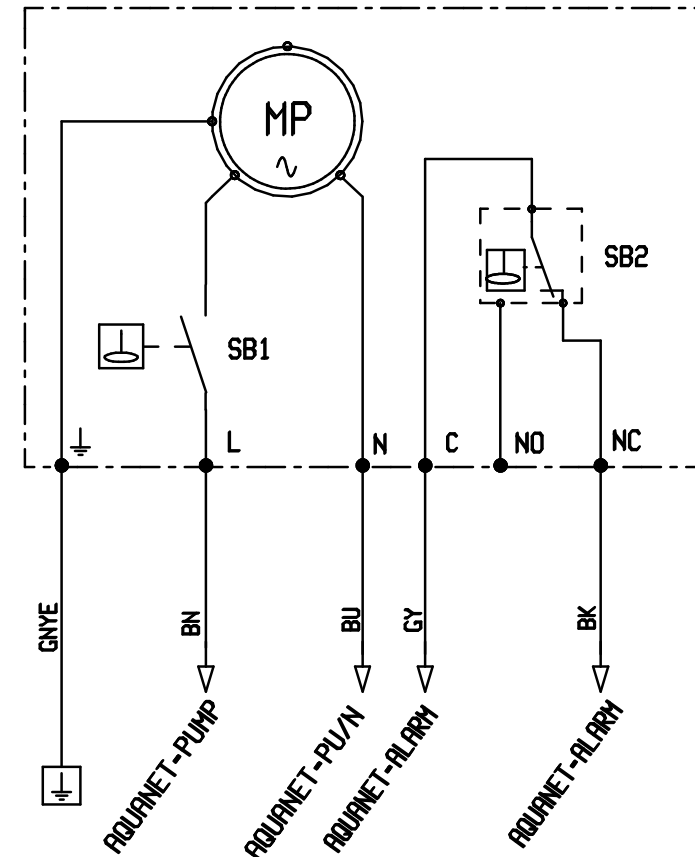

BK	NOIR	BLACK	NEGRO	SCHWARTZ	NERO
BU	BLEU	BLUE	BLU	BLAU	AZUL
GNYE	VERT/JA.	GREEN/YELL.	GIALLO/V.GRUN/G.	VERDE/AM.	VERDE/AM.
BN	BRUN	BROWN	MARRON	BRAUN	MARRONE

MP POMPE DE RELEVAGE CONDENSAT  
 SB1 CAPTEUR DE NIVEAU D'EAU-MARCHE  
 SB2 CAPTEUR DE NIVEAU D'EAU-DEFAUT  
 C SIGNAL "NO" DE DEFAUT EN ATTENTE  
 HD VOYANT SIGNAL DEFAUT (non fourni)

MP CONDENSATE PUMP  
 SB1 WATER LEVEL SENSOR MP ON  
 SB2 WATER LEVEL SENSOR ALARM  
 C CONTACT ALARM"NO" ON STANBY  
 HD ALARM SIGNAL (no fitted)

MP MOTOR POMPA CONDENSATO  
 SB1 SENSORE DI LIVELLO-MARCIA  
 SB2 SENSORE DE LIVELLO-ALLARME  
 C CONTACT"NO"ALLARMA IN ATTESA  
 HD SPIA DIFETTO (non fornita)

MP MOTOR BOMBA CONDENSADO  
 SB1 CAPTADOR DE NIVEL DE AGUA MP  
 SB2 CAPTADOR DE NIVEL DE AGUA(ALARH)  
 C CONTACT"NO"ALARMA EN ESPERA  
 HD INDICADOR LUMINOSO FALLO(no sum.)

MP MOTORPUMP KONDENSAT  
 SB1 WASSERSTANDMESSFUHLER MP EIN  
 SB2 WASSERSTANDMESSFUHLER ALARMSIGNAL  
 C CONTACT"NO" ALARMIERT IN WARTEN  
 HD ALARMLAMPE(bauseits)