

AQU@FAN AHC/AHN: 3-WAY BY PASS VALVES KIT
AQU@FAN AHC/AHN: KIT VANNES 3 VOIES BY PASS
AQU@FAN AHC/AHN: EINBAUSATZ DREIWEGE-UMGEHUNGSVENTIL
AQU@FAN AHC/AHN: KIT VALVOLE 3 VIE BY PASS
AQU@FAN AHC/AHN: KIT VÁLVULAS DE 3 VÍAS BY PASS

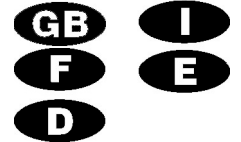

POWER SUPPLY MUST BE SWITCHED OFF BEFORE STARTING TO WORK IN THE ELECTRIC CONTROL BOX!

MISE HORS TENSION OBLIGATOIRE AVANT TOUTE INTERVENTION DANS LES BOITIERS ELECTRIQUES.

VOR JEDEM EINGRIFF AN DEN ANSCHLUSSKÄSTEN UNBEDINGT DAS GERÄT STROMLOS SCHALTEN!

PRIMA DI OGNI INTERVENTO SULLE CASSETTE ELETTRICHE ESCLUDERE TASSATIVAMENTE L'ALIMENTAZIONE!

PUESTA FUERA DE TNESIÓN OBLIGATORIA ANTES DE CUALQUIER INTERVENCIÓN EN LAS CAJAS ELÉCTRICAS!

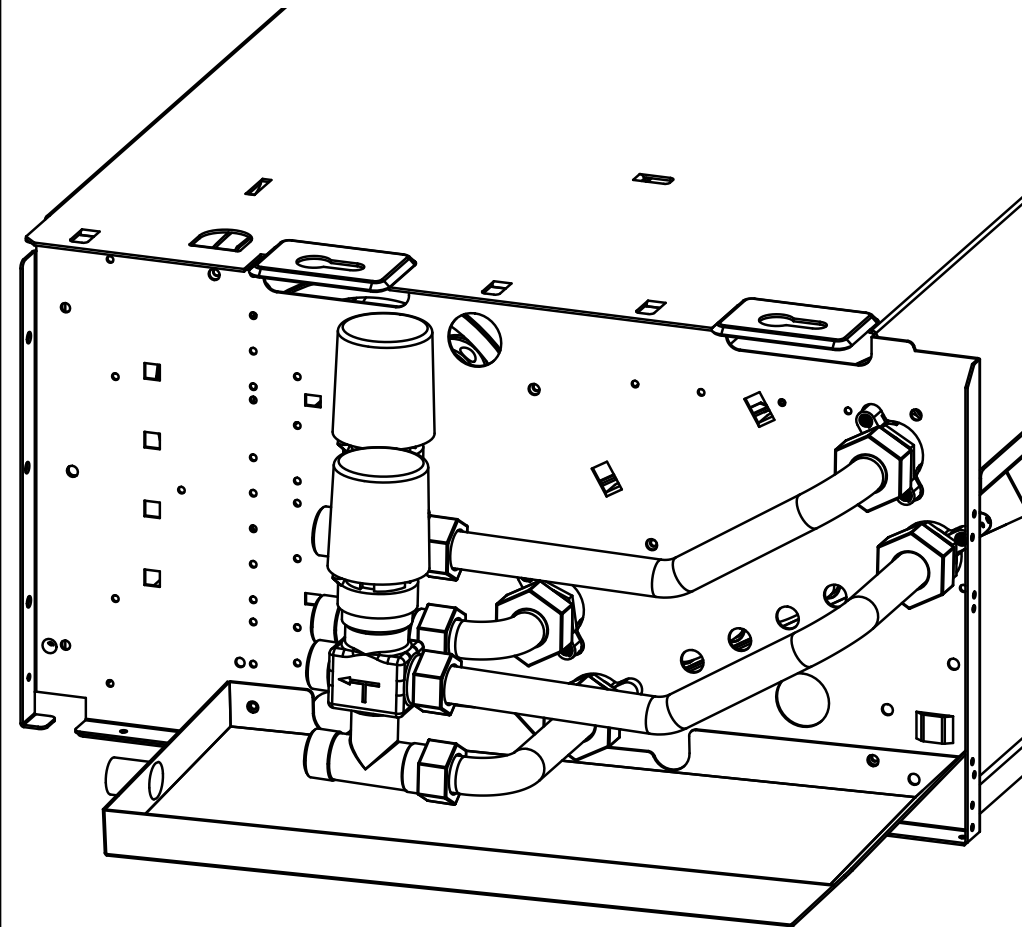

1

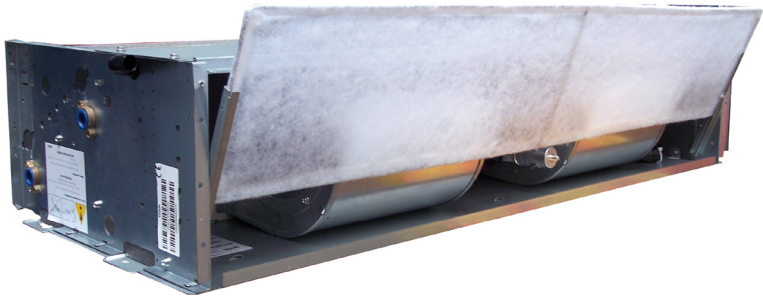

2

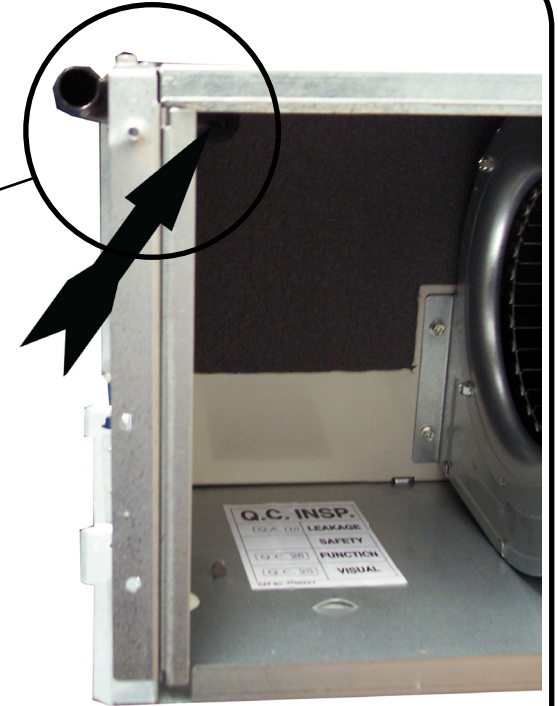
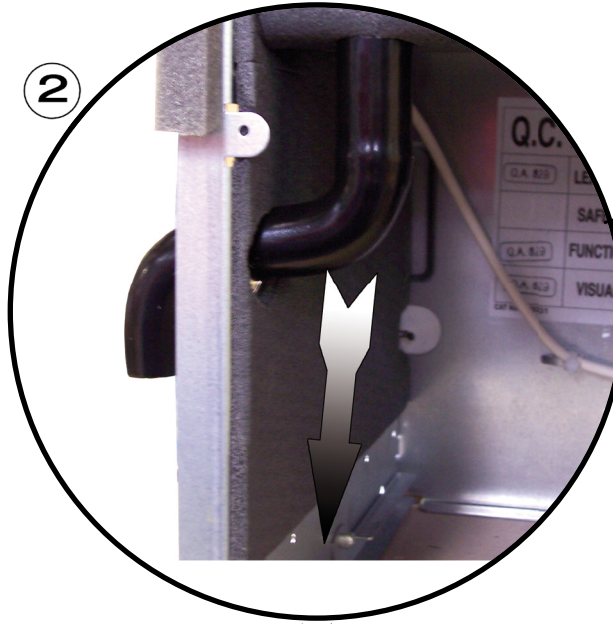

3

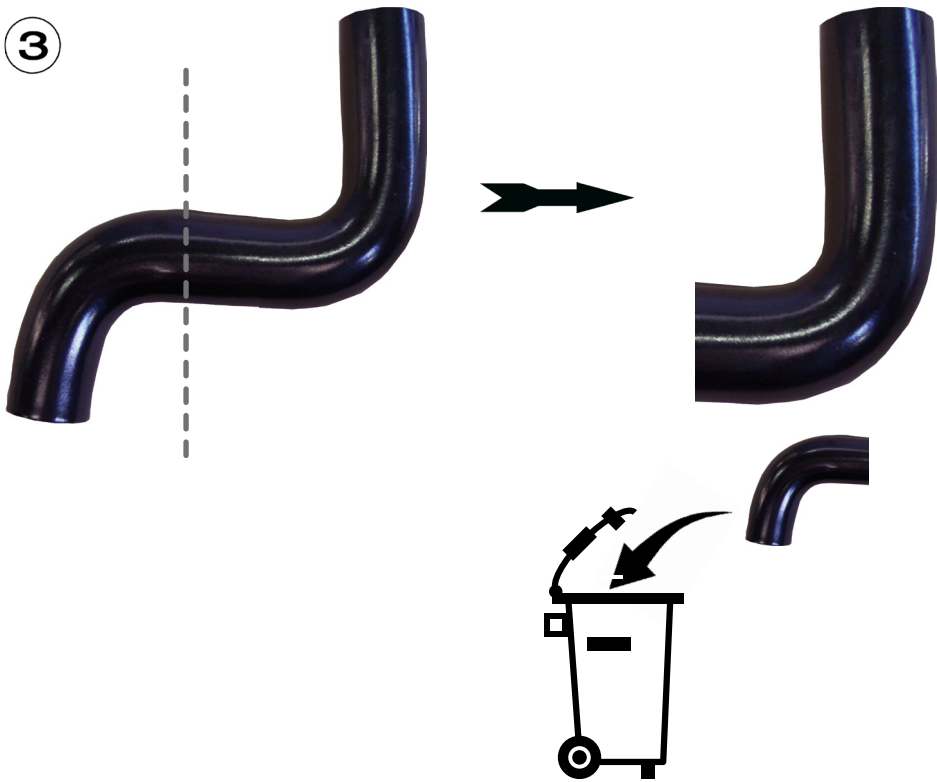

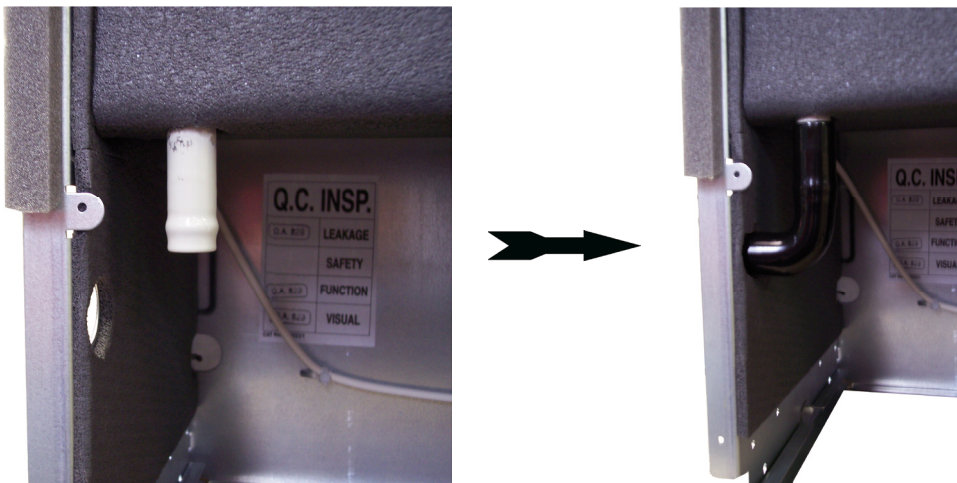

4

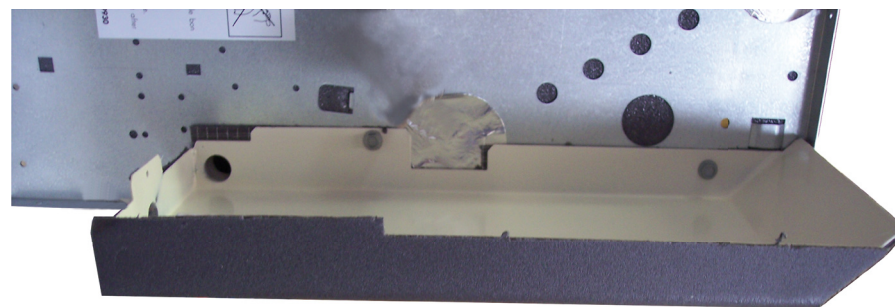
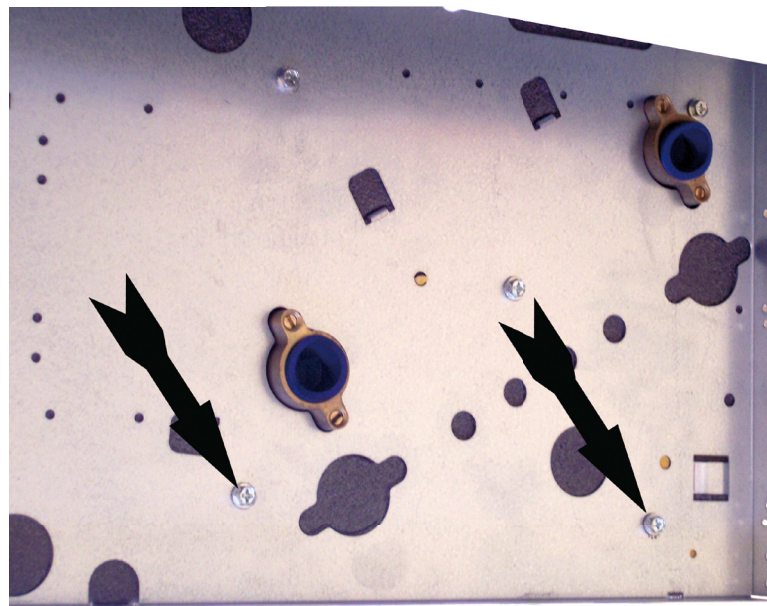

5

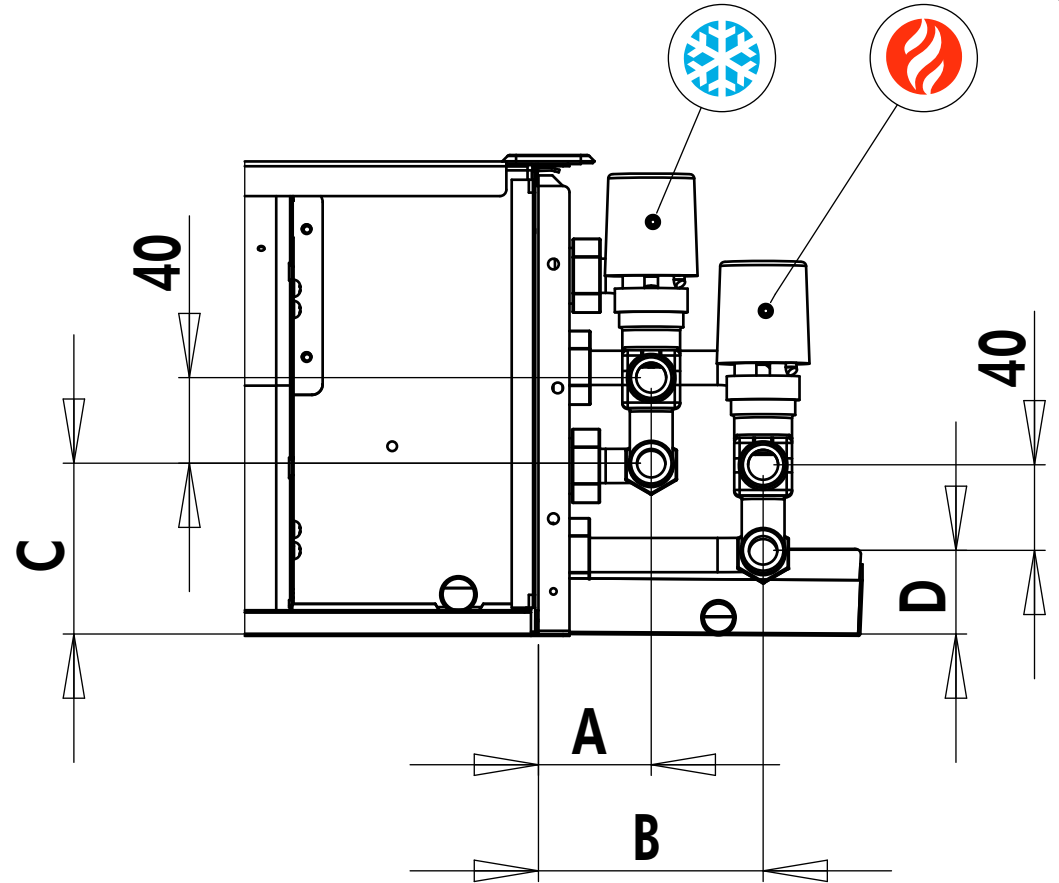
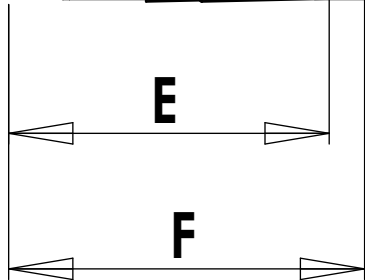
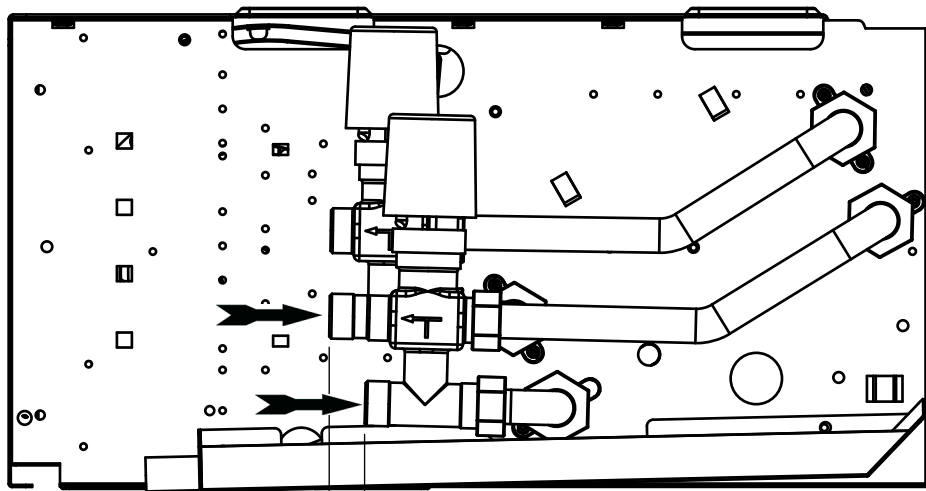



			A	B	C	D	E	F
10	1/2"	1/2"	53	105	79	37	150	167
20								
30								
40								
50								
60	3/4"	1/2"	53	110	75	47	135	157
70					76	33	138	153
80								
90								